



Technical Data Sheet

3mm Silicon PIN Photodiode T-1

PD204-6C/L3

Features

- Fast response time
- High photo sensitivity
- Small junction capacitance
- Pb free
- This product itself will remain within RoHS compliant version.



Descriptions

- PD204-6C/L3 is a high speed and high sensitive PIN photodiode in a standard 3 Φ plastic package. The device is Spectrally matched to visible and infrared emitting diode.

Applications

- Automatic door sensor
- Copier
- Game machine

Device Selection Guide

LED Part No.	Chip	Lens Color
	Material	
PD204-6C/L3	Silicon	Water clear

Package Dimensions

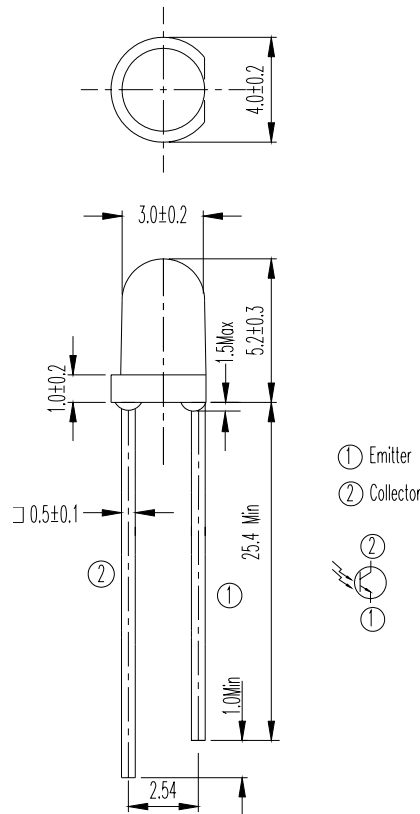

- Notes:** 1.All dimensions are in millimeters
 2.Tolerances unless dimensions $\pm 0.25\text{mm}$

Absolute Maximum Ratings ($T_a=25^\circ\text{C}$)

Parameter	Symbol	Rating	Units
Reverse Voltage	V_R	32	V
Operating Temperature	T_{opr}	-40 ~ +85	$^\circ\text{C}$
Storage Temperature	T_{stg}	-40 ~ +85	$^\circ\text{C}$
Soldering Temperature	T_{sol}	260	$^\circ\text{C}$
Power Dissipation at(or below) 25 $^\circ\text{C}$ Free Air Temperature	P_c	150	mW

Notes: *1:Soldering time ≤ 5 seconds.

Electro-Optical Characteristics (Ta=25°C)

Parameter	Symbol	Condition	Min	Typ	Max	Unit
Rang Of Spectral Bandwidth	$\lambda_{0.5}$	---	400	---	1100	nm
Wavelength Of Peak Sensitivity	λ_p	---	---	940	---	nm
Open-Circuit Voltage	V_{OC}	$E_e=5mW/cm^2$ $\lambda_p=940nm$	---	0.44	---	V
Short- Circuit Current	I_{SC}	$E_e=1mW/cm^2$ $\lambda_p=940nm$	---	10	---	μA
Reverse Light Current	I_L	$E_e=1mW/cm^2$ $\lambda_p=940nm$ $V_R=5V$	---	10	---	μA
Reverse Dark Current	I_D	$E_e=0mW/cm^2$ $V_R=10V$	---	---	10	nA
Reverse Breakdown Voltage	B_{VR}	$E_e=0mW/cm^2$ $I_R=100 \mu A$	32	170	---	V
Total Capacitance	C_t	$E_e=0mW/cm^2$ $V_R=5V$ $f=1MHz$	---	10	---	pF
Rise Time	t_r	$V_R=10V$ $R_L=100 \Omega$	---	10	---	nS
Fall Time	t_f		---	10	---	

Typical Electro-Optical Characteristics Curves

Fig.1 Power Dissipation vs. Ambient Temperature

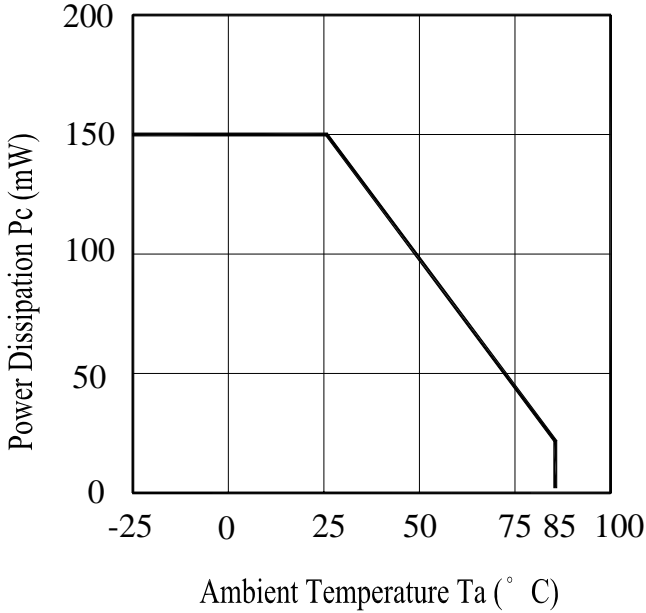

Fig.2 Spectral Sensitivity

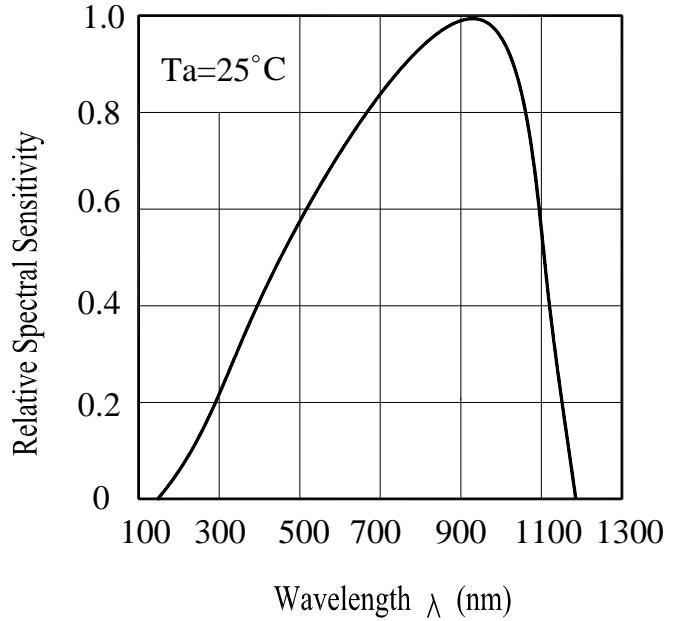

Fig.3 Dark Current vs. Ambient Temperature

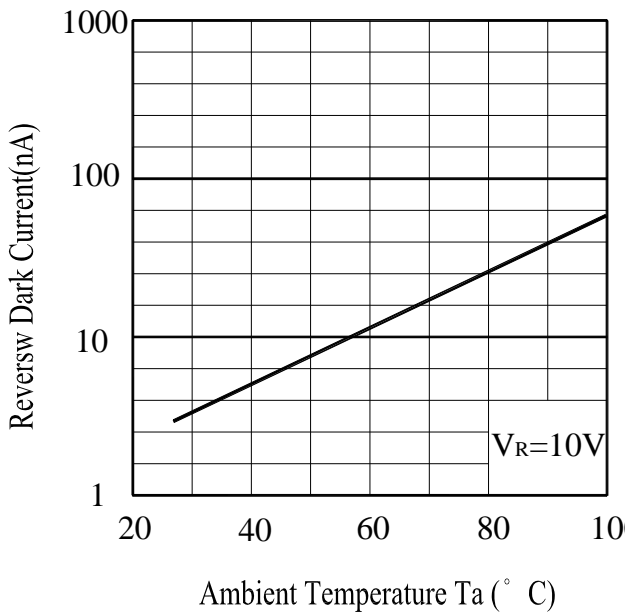
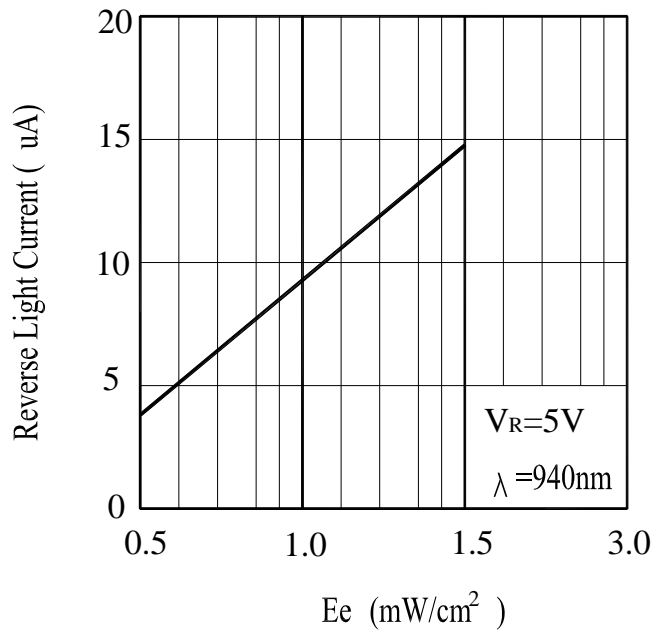

Fig. 4 Reverse Light Current vs. Ee



Typical Electro-Optical Characteristics Curves

Fig.5 Terminal Capacitance vs.

Reverse Voltage

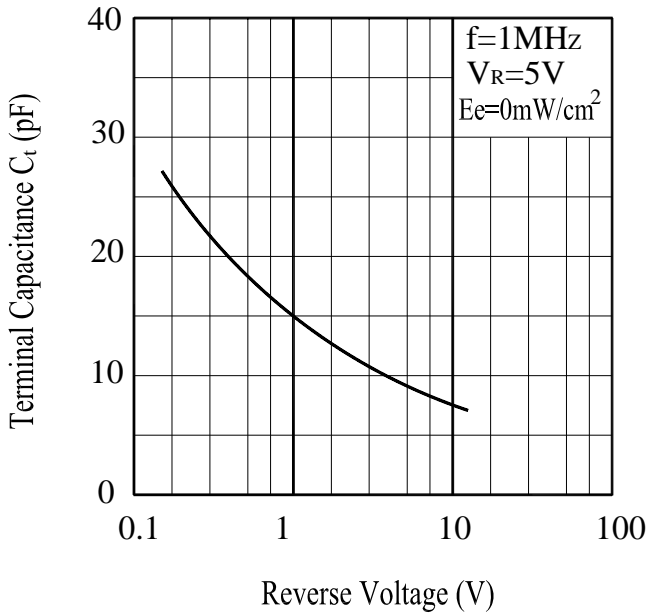
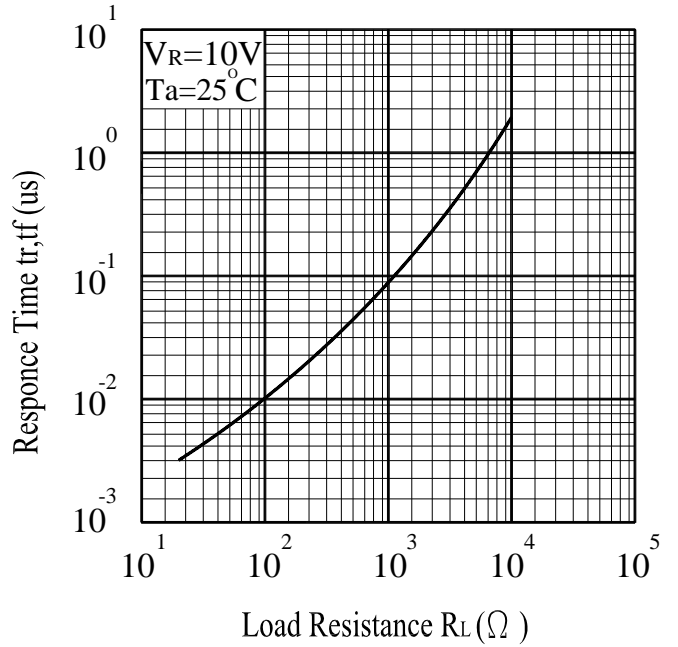

Fig.6 Response Time vs.

Load Resistance



Reliability Test Item And Condition

The reliability of products shall be satisfied with items listed below.

Confidence level : 90%

LTPD : 10%

NO.	Item	Test Conditions	Test Hours/ Cycles	Sample Sizes	Failure Judgement Criteria	Ac/Re
1	Solder Heat	TEMP. : 260°C±5°C	10secs	22pcs		0/1
2	Temperature Cycle	H : +100°C 15mins ↑ 5mins ↓ 15mins L : -40°C	300Cycles	22pcs	$I_L \leq L \times 0.8$ L : Lower	0/1
3	Thermal Shock	H : +100°C 5mins ↑ 10secs ↓ 5mins L : -10°C	300Cycles	22pcs	Specification Limit	0/1
4	High Temperature Storage	TEMP. : +100°C	1000hrs	22pcs		0/1
5	Low Temperature Storage	TEMP. : -40°C	1000hrs	22pcs		0/1
6	DC Operating Life	$V_R=5V$	1000hrs	22pcs		0/1
7	High Temperature/ High Humidity	85°C / 85% R.H	1000hrs	22pcs		0/1



Packing Quantity Specification

- 1.1000PCS/1Bag , 4Bags/1Box
- 2.10Boxes/1Carton

Label Form Specification



- CPN: Customer's Production Number
- P/N : Production Number
- QTY: Packing Quantity
- CAT: Ranks
- HUE: Peak Wavelength
- REF: Reference
- LOT No: Lot Number

Notes

1. Above specification may be changed without notice. EVERLIGHT will reserve authority on material change for above specification.
2. When using this product, please observe the absolute maximum ratings and the instructions for using outlined in these specification sheets. EVERLIGHT assumes no responsibility for any damage resulting from use of the product which does not comply with the absolute maximum ratings and the instructions included in these specification sheets.
3. These specification sheets include materials protected under copyright of EVERLIGHT corporation. Please don't reproduce or cause anyone to reproduce them without EVERLIGHT's consent.

EVERLIGHT ELECTRONICS CO., LTD. *Tel: 886-2-2267-2000, 2267-9936*
Office: No 25, Lane 76, Sec 3, Chung Yang Rd, *Fax: 886-2267-6244, 2267-6189, 2267-6306*
Tucheng, Taipei 236, Taiwan, R.O.C *http:\\www.everlight.com*